tri-art audio
User Manual

B-Series

5 open speakers



*Read the user manual
before operating.

With Crossover Product #18395
Without Crossover Product #10844

safety information

Before you start...

Warning of a hazard for the user, the unit or possible misuse. Important notice.



Thank you for buying a Tri-Art Audio product. Please read through this manual to understand and operate this product correctly. Please keep this manual in a safe place so that you may refer to it whenever necessary. Please ensure the product you are using is rated for your country's electrical system, or it will not be covered under our warranty.

Warning:

To prevent fire or shock hazard, do not expose this product to rain or moisture.

Important Notice:

The serial number for this equipment is located on the bottom of this component. Please write this serial number on the enclosed warranty card and follow the instructions to register your product for our three (3) year limited warranty.

This equipment is designed for consumer use, such as home audio systems. It is not designed to operate in a business environment or a mobile application. Mobile, pro or commercial businesses such as restaurants will not be covered under warranty.

Caution:

To reduce the risk of electric shock, or damage do not remove drivers. No user serviceable parts inside. Refer servicing to qualified service personnel.



safety information

Safety Instructions

Read Instructions:

All the safety and operating instructions should be read before operating this equipment.

Retain Instructions:

The safety and operating instructions should be retained for future reference.

Heed All Warnings:

All warnings, set up procedures, and operating instructions should be strictly adhered to. Follow all instructions carefully.

Water and Moisture:

Under no circumstances should this audio component be used near water. It is not to be used in a bathroom, water closet, shower, kitchen, wet basement, pool/spa/sauna area, or outside.



safety information

Safety Instructions

Heat:

This product should be located well away from all the heat sources such as but not limited to heaters, forced air heat, radiators, stoves, and fireplaces.

Cleaning:

Your Tri-Art product was soaked and finished in hemp oil. Do not use lacquers or aerosol wax products with this product. Do not pour water on the surface at any time.

Heavy Objects:

Do not place heavy objects on this component.



speaker front

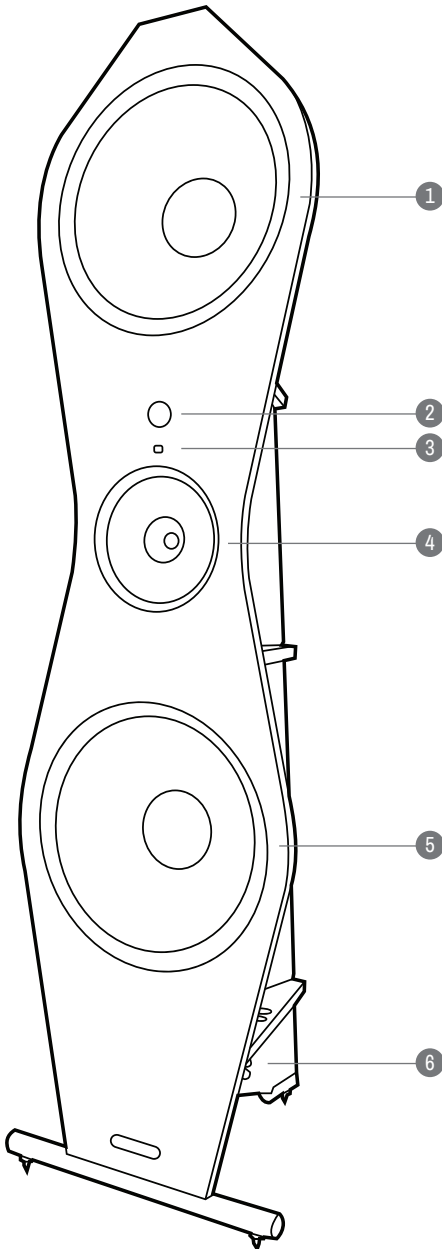

- ① Bass Driver
- ② Dome Tweeter
- ③ Super Tweeter
- ④ Full Range Driver
- ⑤ 15" Sub Bass Driver
- ⑥ Speaker Inputs



speaker back

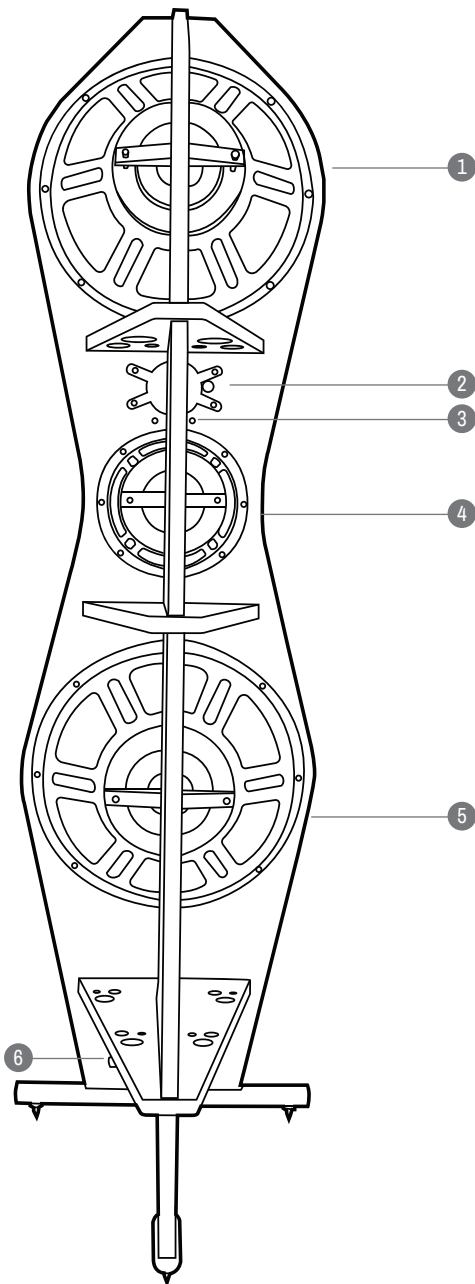

- ① Bass Driver
- ② Dome Tweeter
- ③ Super Tweeter
- ④ Full Range Driver
- ⑤ 15" Sub Bass Driver
- ⑥ Speaker Inputs



speaker specs

Speaker Details:

Design:	Open Baffle
Nominal Impedance:	Single Input 8 Ω
Recommended Amplifiers:	25 Up to 150 Watts RMS
Sensitivity:	92 dB SPL (1W/1M)
Volume Matching:	Crossover Only
Frequency Range:	27 – 20,000 Hz (+/- 3dB)

Driver Details:

Total Drivers:	Five
Input 1:	1" Fabric Dome Tweeter (13,000 Hz and up) 20 Watts 8" Full Range Paper Cone Cloth Edge Super Tweeter (40,000 Hz)
Input 2:	Up to 150 Watts Two 15" Paper Cone Cloth Edge Woofers Top 15" : 27-100Hz @ 1st Order 6dB Slope Bottom 15" : 27-50Hz @ 1st Order 6 dB Slope

Body Details:

Mode:	Floor Standing
Finish:	Bamboo Laminate Soaked in Hemp
Stands:	Bamboo Stand with 4 Brass-Collared, Bronze Spikes with Bamboo Spike Cups
Dimensions:	H: 62" (1574.8mm) x D: 16 ¼" (412.75mm) x W: 19" (482.76)



Crafted with bamboo and natural sheep's wool.
Learn more at [triartaudio.com](https://www.triartaudio.com)



crossover specs

* The crossover is an *optional* addition to the 5 Open Speakers.

Inputs:	(Two) 2	
Adjustable Volume Control for Full Range Speaker Section:		Crossover Only
Outputs:	(Three) 3	
Cables:	Set of 0.5-meter jumper cables with banana plugs.	
Output 1 (Full Range):	100-Watt Attenuator 47-Ohm Resistor 100 Hz Single Cap Filter	
Output 2 (Bass):	Single open-air inductor filter 100Hz @ 1st Order 6 dB Slope	
Output 3 (Sub Bass):	Single open-air inductor filter 50 Hz @ 1st Order 6 dB Slope	



included in the box

Initial Check

The Open Five Series is shipped in two (2) oversized boxes. Within these boxes you will find Two (2) crossover boxes. Upon receiving the boxes please check their condition and ensure the arrows on the box are pointing upward. If any of the packaging is or even appears to be damaged, please report it to the shipping company immediately for insurance verification. We always suggest keeping the original packing for maximum resale value or for safely moving the equipment to a different location. **Please fill out the warranty card.**

The serial numbers for the speakers are located at the bottom of the speakers.

The following items are recommended for this procedure:

- Allen Key
- Spirit Level
- Digital Measuring Tool

Removing the Speaker from the Box

A minimum of two strong adults is required to set up the Open 5 Speakers. Locate the two largest boxes. These contain the baffle enclosures and are the first components of the system to unpack.

Note: These speaker enclosures are very heavy, and care should be taken to prevent injury.



1. With the arrow labels facing up, carefully cut or remove the binding tape. Gently remove the lid.
2. Select the speaker by lifting it by grasping any one of the holes and secure it. Pay mind not to squeeze any wiring and do not touch the drivers.
3. Firmly grasp the back of wood panel with both hands. Carefully, so as not to hit the speaker on the side of the box, carefully lift the enclosure out of the box.
4. Ensure that you place the speakers on the floor carefully positioning them in their cradle feet.

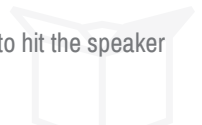

included in the box

Checklist: What's in the Box?

Now that you have unpacked all your open 5 boxes, you can review your inventory to ensure you have everything you need.

- 1 – Owner's Manual
- 1 – Warranty Registration
- 8 – 3/8" Spikes (4 per speaker)
- 2 – 2 Piece Front and Back Bamboo Stand
- 8 – Bamboo Spike Cups
- 1 – 1/8" Allen Wrench
- 2 – Open 5 OB Speakers

For Models Supplied with Passive Crossovers

- 2 – Crossovers with three outputs (can be bi-wired or bi-amped) come standard jumpers for single amplifier use.
- 3 – Directional single strand copper speaker cables with banana plugs.



use & guidelines

Setting up the Open 5 Series Speakers

The open Series of speakers is an open Baffle design. There is no box to add colourations or enhance the sound. Therefore it is important to place the speakers as far away from the back wall as possible. We suggest to use the rule of thirds.

Ensure the power is off, the volume at 0 or mute switch is on before connecting your speakers or inputs.

In most cases the best sound will come from positioning your speakers against the back walls with the long walls on the side.

1. If possible, Place the speaker approximately $\frac{1}{3}$ of the way into the room.
2. Locate the spikes and install them on the base feet.
3. With the speakers in their desired position in the room, the spikes on the base feet, you are now ready to level the speakers. Begin with the front back tilt and bring this to level. Then level the side to side. **PLEASE NOTE:** Open Baffle speakers perform best when positioned $\frac{1}{3}$ into the room. If this is not possible, try $\frac{1}{6}$ of the room. We strongly suggest you use a laser measure for accurate placements.
4. Connect the three pairs of crossover cables to the speakers.
5. Connect the crossover to your amplifier in the Single amp or Bi Amp configuration.

See *Figure 1*.

Please Note If You Are Not Using The Tri-Art Audio Crossover, please refer to the crossover manufacturers connection instructions.

The Open 5 and Open 4 do not have internal crossovers.



use & guidelines

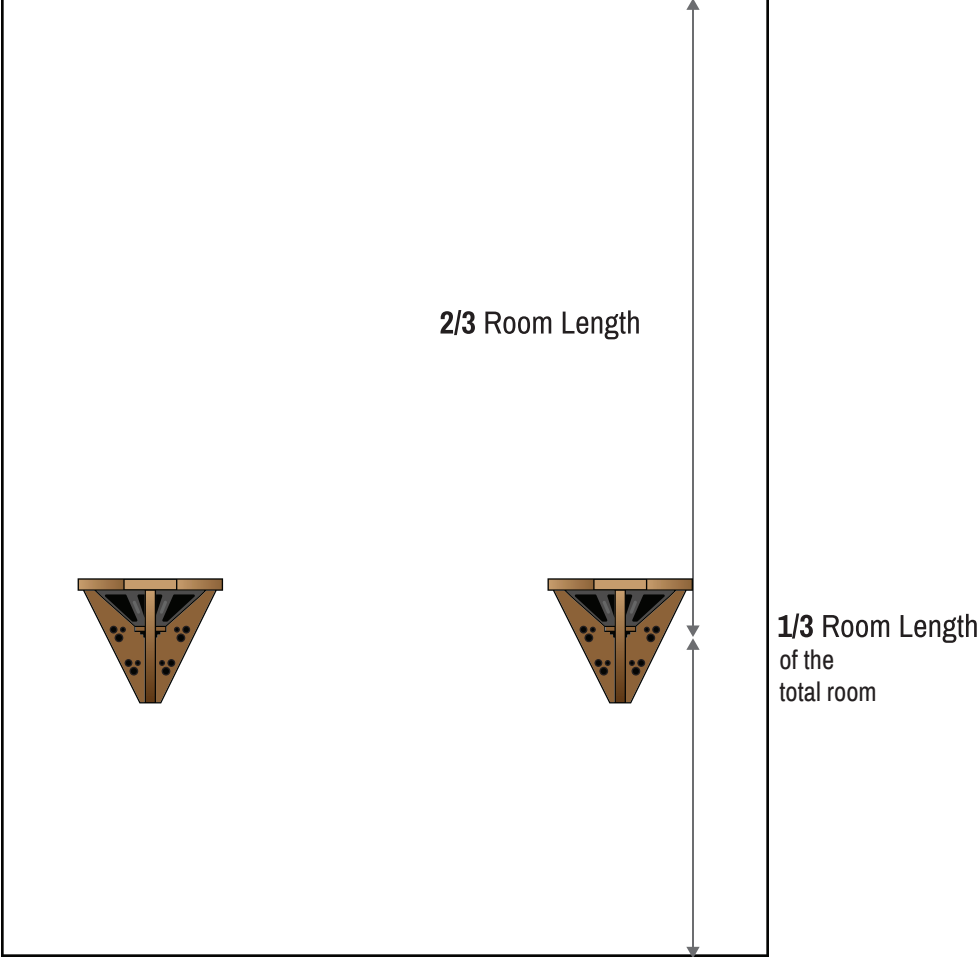

Figure 1



5 Open Speaker Placement



use & guidelines

Connecting to the Crossover

The Open 5 Speakers have three stereo pairs of inputs. The sub bass input is located the closest to the faceplate of the speaker, the full range input is located in the middle of the inputs, and the bass input is furthest from the faceplate. The open five comes complete with three pairs of cables to connect these speakers to the crossover, when the open five crossover has been purchased. **If you are not using a Tri-Art Audio Crossover please refer to the manufacturer's crossovers manual.**

They are labelled as follows from left to right:
5 Open Speakers Inputs

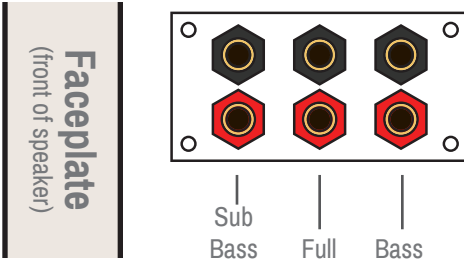

Connect the three stereo pair cables to the crossover, carefully matching the connections including phase (colour).

Crossover Outputs

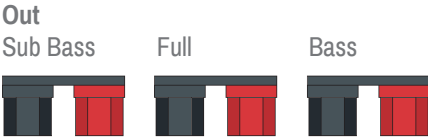

Crossover Inputs

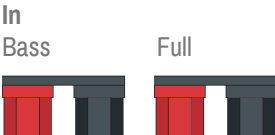

use & guidelines

Single Amplifier Set Up

To use the crossovers with a single amplifier, ensure the jumpers are connected as follows.



Loosen the the crossover input covers by turning them to the left and revealing the holes for the jumper cables. Connect the **Full and Bass Inputs** together with the **jumper cables** by inserting the jumper cables into the holes. Red to red and black to black, then tighten the covers by turning them to the right.

CAUTION:

The speaker posts are not designed to be overtightened. They are manufactured to achieve a snug connection fit which we feel offers a far better musical performance than compression of the metal. This finger tight connection is achieved as soon as you feel resistance. Do not use tools to tighten and do not overtighten as damage to the posts will occur.

We recommend banana cables for speaker connections. Avoid bulky cables with spades if possible.

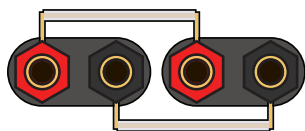

Jumper cables correctly connected to the crossover inputs.

Connect the output from your stereo amplifier to the input marked FULL (Right).

Dual Amplifier Set Up

To Bi Wire:

Remove the jumper cables. Connect the desired amplifier for bass to the BASS input connect the desired amplifier for Full range to the FULL input.



use & guidelines

Volume Matching

The crossover has an attenuator located on the top panel. This is not a volume switch! The crossover attenuator (shown here set to 0) allows you to set the output of the drivers to match the bass response of the room. This feature permits a balanced sound and truly exceptional performance.

(Image Shows Set to 0 or Off Setting)

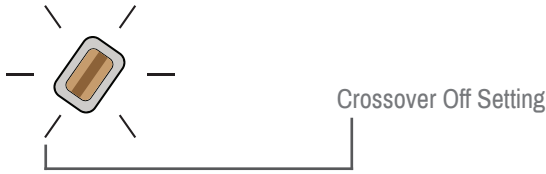

Troubleshooting

Bass not defined, diffused or weak bass:

1. Speaker are too close to the back wall (move away from back wall).
2. Crossovers are not wired correctly in phase.
3. Source amplifier(s) are not in phase.

Rattle sound:

1. Loose fastening in back of speaker.
2. Clipping of your amplifier.

Strange fizz or buzz sound:

Blown Driver — Contact service do not attempt to replace.

Dome Tweeter pushed in:

Contact factory for instructions.



congratulations!

Your Tri-Art Audio speakers is operational and fully set up.

Now, go play your favourite record!

Our Bamboo Design

We have selected bamboo to construct many of the structural parts of our systems rather than metal or plastic.

The sonic virtues of bamboo are evident. We use the latest CNC machinery to manufacture to precise tolerances. Due to the nature of the material, there may be slight variations that do not comprise the sound. Every component is hand finished and then inspected by the designer before it leaves the factory.



Crafted with bamboo and natural sheep's wool.

Learn more at triartaudio.com

warranty information

For Your Protection:

Completely and immediately mail the product registration card so that we may contact you directly in the event a safety notification is issued in accordance with the 1972 Consumer Safety Act, or for other reasons Tri-Art Audio may deem necessary.

Technical Support Hotline 1-877-541-0299

Our technical department will gladly answer any questions you may have about our products. Monday through Thursday, 9am to 5pm and Friday, 9am to 3pm EST.

Manufacturer's Limited Three Year Warranty:

Tri-Art Audio warrants this unit to be free from defective material or workmanship and will repair or replace this unit or any part thereof if it proves defective in normal use or service within three (3) years from the date of original purchase.

This warranty will be considered void if the unit has been tampered with, improperly serviced, subjected to abuse or misuse or if installed in a commercial vehicle. This warranty does not cover accidental damage.

For all warranty information please see Tri-Art Audio's warranty information card included with your new equipment.



tri-art audio

triartaudio.com



Designed . Fabricated . Assembled
In Canada